

Durable Corporation  
(800) 537-1603

Model: B612-51-A3

MODEL: B612-51-A3

Size  
Projection 6"  
Height 12"

Length:  
-Overall 53"  
-Anchor Holes 51"  
-Rubber 47"  
Angle Size 1/4" X 3" X 4" X 1-1/2"

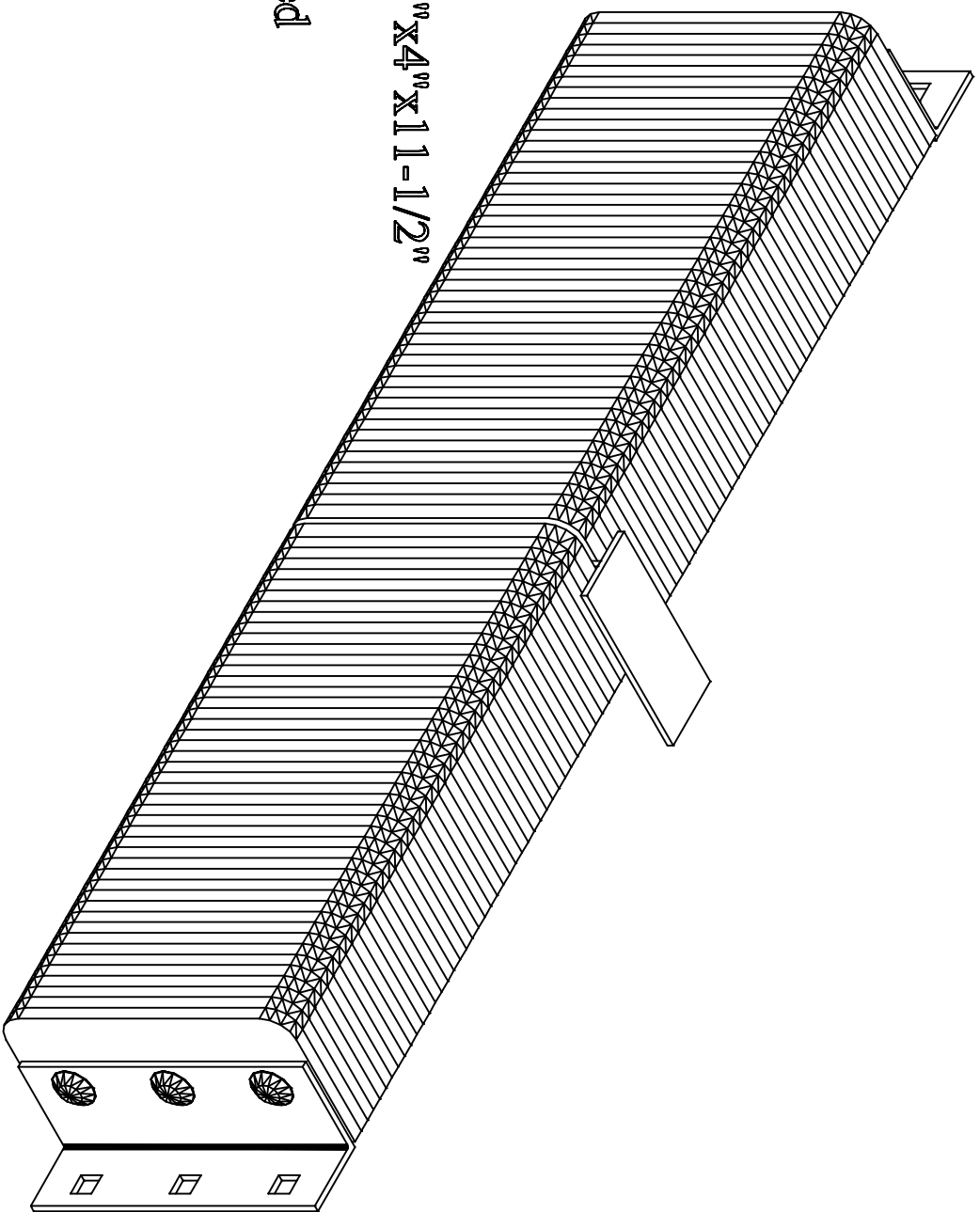

Bolt Heads Are Inscribed  
"DURABLE CORP"

Date: 11/01/15

All measurements are +/- 1/8"

Confidential -- Property of Durable Corporation