

Durable Corporation
(800) 537-1603

Model: B612-87-A3

MODEL: B612-87-A3

Size
Projection 6"
Height 12"

Length:
-Overall 89"
-Anchor Holes 87"
-Rubber 83"
Angle Size 1/4"x3"x4"x1-1/2"

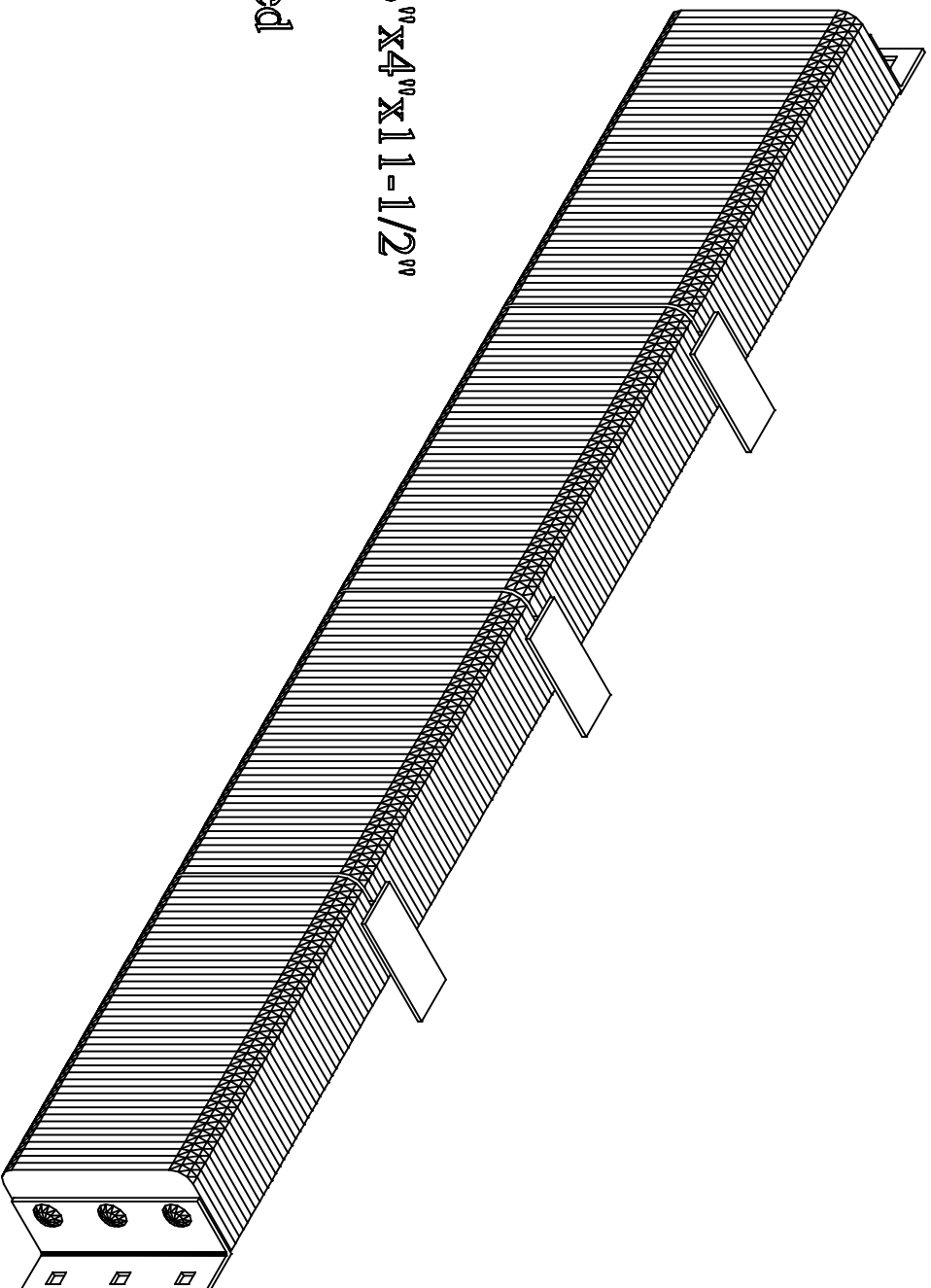

Bolt Heads Are Inscribed
"DURABLE CORP"

Date: 11/02/15

All measurements are +/- 1/8"

Confidential -- Property of Durable Corporation