

Durable Corporation
(800) 537-1603

Model: B610-63-A3

MODEL: B610-63-A3

Size
Projection 6"
Height 10"

Length:
-Overall 65"
-Anchor Holes 63"
-Rubber 59"
Angle Size 1/4" X 3" X 4" X 9-1/2"

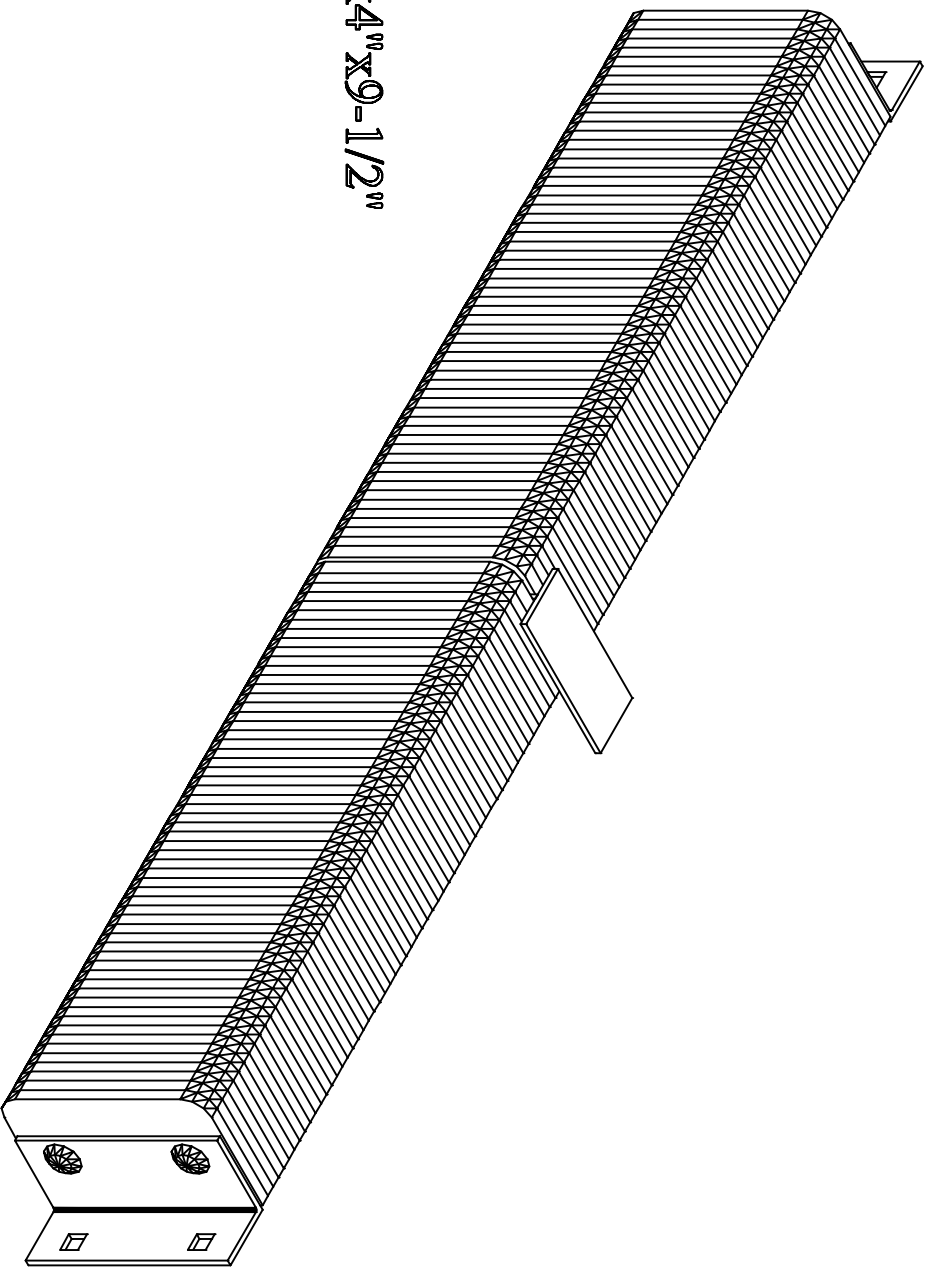

Bolt Heads Are Inscribed
"DURABLE CORP"

Date: 11/02/15

All measurements are +/- 1/8"

Confidential -- Property of Durable Corporation